

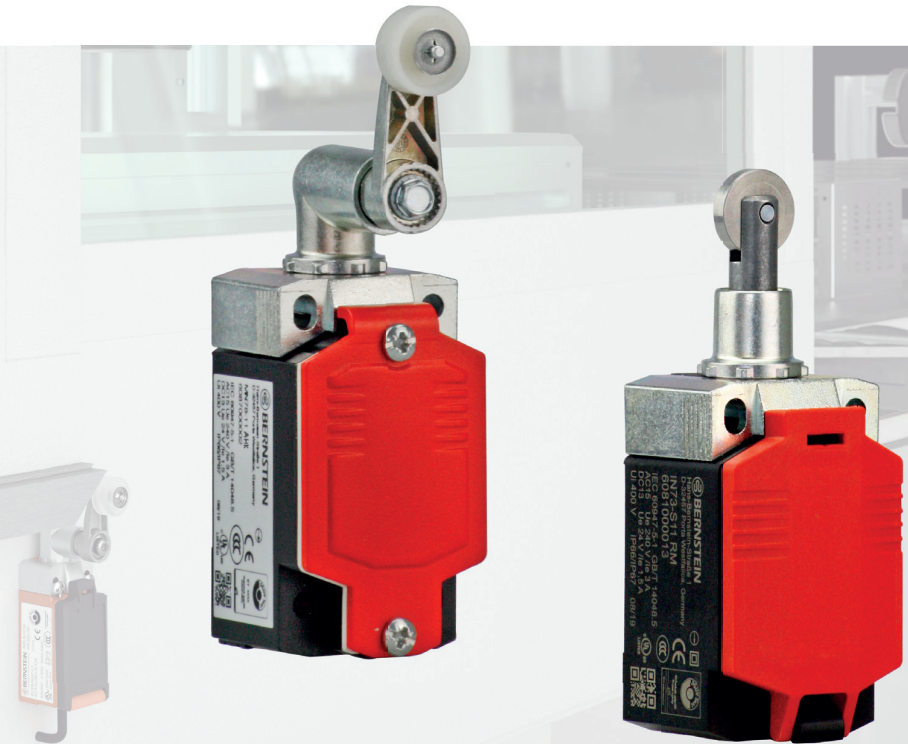

**We make
safety happen.**



Position switches
IN73 and MN78

Plastic enclosures

Position switches Plastic IN73

NEW



2 OR 4 CONTACTS

Good to know ...

Our new standard switch, the IN73, is the latest in our ENK-series. It offers a modular, robust enclosure and a wide range of actuators made of metal. In mechanical and plant engineering, it is used as a position and safety switch in rough environments as it features additional fixing holes to achieve a better installation.

The "big brother" of the IN65, it has a similar modular design, however there is an important difference: Whereas the C14 switch insert (introduced on page 26) has 2 contacts, the IN73 can be equipped with the C17 switch insert with 4 contacts.

The modular design and the easy way to change the actuator allows for a great variety of applications, for example for monitoring doors, hoods, and flaps, or for detecting the position of moving machine parts. The IN73 is as cost effective as a plastic enclosed switch, robust to install like a metal switch, and clever due to its modular design and easy to change actuators.

Technical design

- Slow- and snap-action
- **Versions:**
 With C14 switch insert: 2 NC, 2 NO, 1 NC/1 NO
 With C17 switch insert: 4 NO, 4 NC, 2 NO/2 NC
 1 NC/3 NO and 3 NC/1 NO

Technical data

Electrical data		
Design insulation voltage	U_i max.	400 V AC
Conventional thermoelectric current	(up to) I_{the}	5 A
Rated operating voltage	U_e max.	240 V AC
Utilisation category (up to)		AC-15, U_e/I_e 240 V/3 A DC-13 U_e/I_e 24 V/1.5 A
Short-circuit protection (up to)		Safety fuse 4 A gG
Protection class		II, protective insulation
Mechanical data		
Enclosure/Cover material		Thermoplastics, glass-fibre reinforced (UL 94-V0)
Ambient temperature		-30 °C to +75 °C
Mechanical lifetime (up to)		10×10^6 switching cycles
B10d NC Contact cycles (up to)		20 million
B10d NO Contact cycles (up to)		1 million
Switching frequency		≤ 60 /min.
Type of connection		4 screwed connections (M3)
Conductor cross-sections		Single-wire 0.5 – 1.5 mm ² or strand with wire-end ferrule 0.5 – 1.5 mm ²
Cable entry		1 × M20 × 1.5
Protection class		IP66/IP67 according to EN 60529; DIN VDE 0470 T1
Standards		
VDE 0660 T211, DIN EN 60947-5-4, IEC 60947-5-4 DIN EN ISO 13849-1, DIN EN ISO 13849-2		
① Depending on switching system		

Product characteristics

- High reliability at low currents (1 mA/24 VDC)
- Up to 4 contacts
- Actuator and installation collar with mounting holes made of metal
- Easy turning (8 x 45°) and changing of the actuators without a tool
- Standard switch and standard actuator according to DIN EN 50041
- Protection class IP66 and IP67 according to EN 60529



Options

- Available with an M12 connector
- On request, available with customised cables and connectors

Mounting

- 2 oval holes for adjustment for M5 screws
- 2 round holes for M5 screws for fixing when used for safety applications

POSITION SWITCHES PLASTIC IN73

IN73-... SM

Replacement actuator: 3918022415

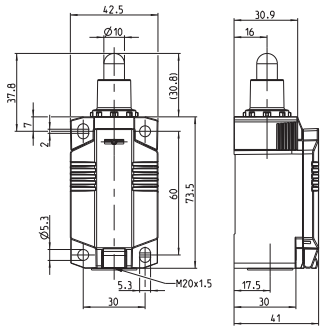

	1 NC / 1 NO	2 NC	2 NO	2 NC / 2 NO
Slow-action system	608100002 IN73-11 SM 	608100004 IN73-20 SM 	608100006 IN73-02 SM 	608100008 IN73-22 SM
Snap-action system	608100001 IN73-S11 SM 	608100003 IN73-S20 SM 	608100005 IN73-S02 SM 	

	4 NC	4 NO	3 NC / 1 NO	1 NC / 3 NO	1 NC / 1 NO overlapping
Slow-action system	608100009 IN73-40 SM 	608100010 IN73-04 SM 	608100011 IN73-31 SM 	608100012 IN73-13 SM 	608100007 IN73-V11 SM

Replacement actuator: 3918172417

IN73-... RM

	1 NC / 1 NO	2 NC	2 NO	2 NC / 2 NO
--	-------------	------	------	-------------

Slow-action system

608100014
IN73-11 RM

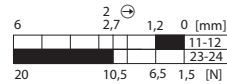

608100016
IN73-20 RM

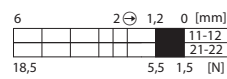

608100018
IN73-02 RM

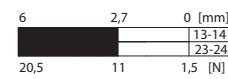

608100020
IN73-22 RM

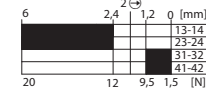

Snap-action system

608100013
IN73-S11 RM



608100015
IN73-S20 RM

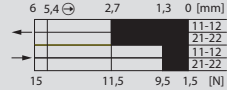

608100017
IN73-S02 RM

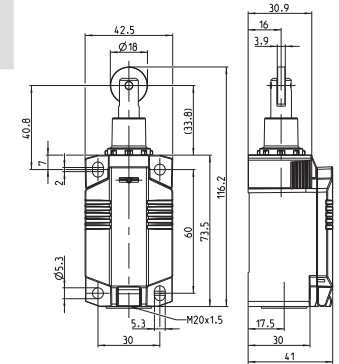
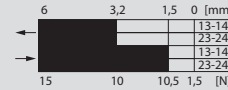

	4 NC	4 NO	3 NC / 1 NO	1 NC / 3 NO	1 NC / 1 NO overlapping
--	------	------	-------------	-------------	-------------------------

Slow-action system

608100021
IN73-40 RM

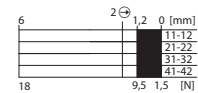

608100022
IN73-04 RM

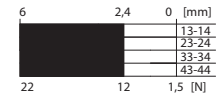

608100023
IN73-31 RM

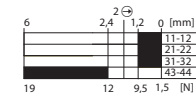

608100024
IN73-13 RM

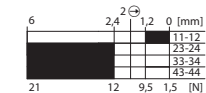

608100019
IN73-V11 RM

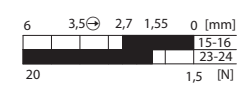

POSITION SWITCHES PLASTIC IN73

IN73-... HK

Replacement actuator: 3918202432

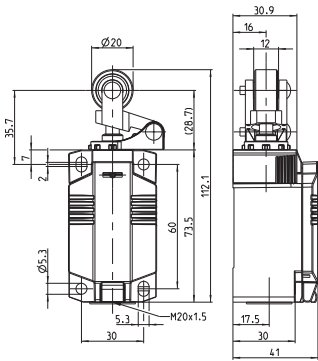

	1 NC / 1 NO	2 NC	2 NO	2 NC / 2 NO
--	-------------	------	------	-------------

Slow-action system

6081000026
IN73-11 HK

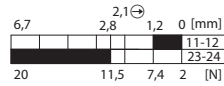

6081000028
IN73-20 HK

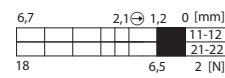

6081000030
IN73-02 HK

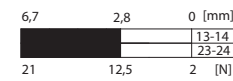

6081000032
IN73-22 HK

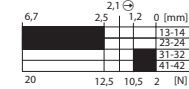

Snap-action system

6081000025
IN73-S11 HK

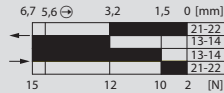

6081000027
IN73-S20 HK

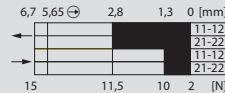

6081000029
IN73-S02 HK

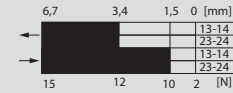

	4 NC	4 NO	3 NC / 1 NO	1 NC / 3 NO	1 NC / 1 NO overlapping
--	------	------	-------------	-------------	-------------------------

Slow-action system

6081000033
IN73-40 HK

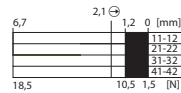

6081000034
IN73-04 HK

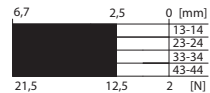

6081000035
IN73-31 HK

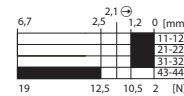

6081000036
IN73-13 HK

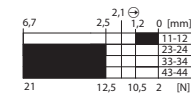

6081000031
IN73-V11 HK

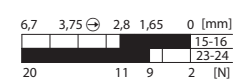



Replacement actuator: 3918202428

IN73-... DGHK

	1 NC / 1 NO	2 NC	2 NO	2 NC / 2 NO
--	-------------	------	------	-------------

Slow-action system

6081000038
IN73-11 DGHK

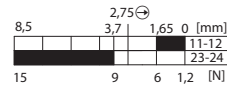

6081000040
IN73-20 DGHK

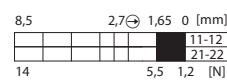

6081000042
IN73-02 DGHK

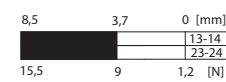

6081000044
IN73-22 DGHK

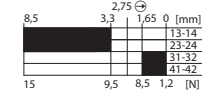

Snap-action system

6081000037
IN73-S11 DGHK

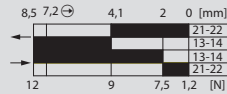

6081000039
IN73-S20 DGHK

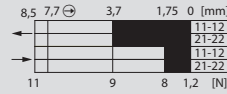

6081000041
IN73-S02 DGHK

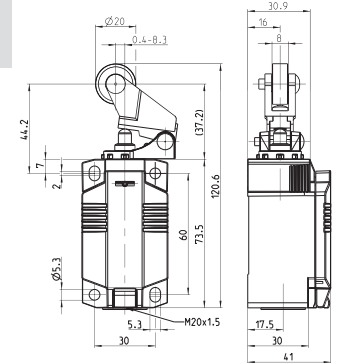
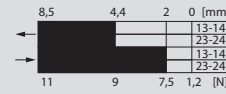

	4 NC	4 NO	3 NC / 1 NO	1 NC / 3 NO	1 NC / 1 NO overlapping
--	------	------	-------------	-------------	-------------------------

Slow-action system

6081000045
IN73-40 DGHK

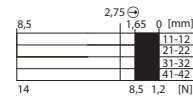

6081000046
IN73-04 DGHK

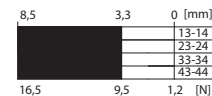

6081000047
IN73-31 DGHK

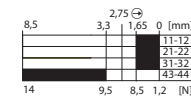

6081000048
IN73-13 DGHK

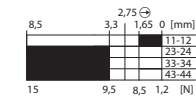

6081000043
IN73-V11 DGHK



POSITION SWITCHES PLASTIC IN73

IN73-... DGKK

Replacement actuator: 3918202430

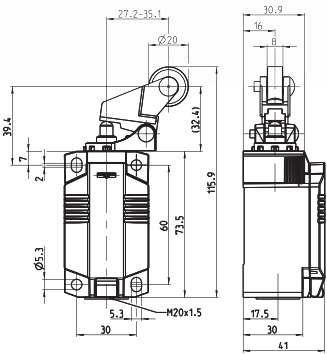

	1 NC / 1 NO	2 NC	2 NO	2 NC / 2 NO
--	-------------	------	------	-------------

Slow-action system

608100050
IN73-11 DGKK

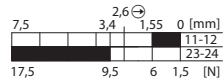

608100052
IN73-20 DGKK

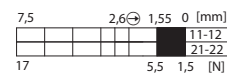

608100054
IN73-02 DGKK

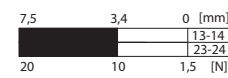

608100056
IN73-22 DGKK

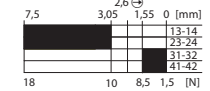

Snap-action system

608100049
IN73-S11 DGKK

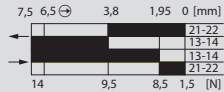

608100051
IN73-S20 DGKK

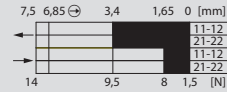

608100053
IN73-S02 DGKK

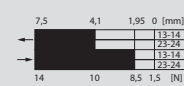

	4 NC	4 NO	3 NC / 1 NO	1 NC / 3 NO	1 NC / 1 NO overlapping
--	------	------	-------------	-------------	-------------------------

Slow-action system

608100057
IN73-40 DGKK

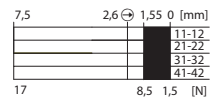

608100058
IN73-04 DGKK

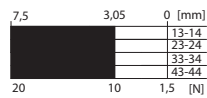

608100059
IN73-31 DGKK

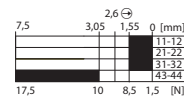

608100060
IN73-13 DGKK

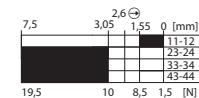

608100055
IN73-V11 DGKK

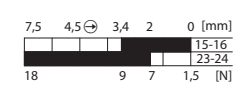



Replacement actuator: 3918352393

IN73-... AHK



	1 NC / 1 NO	2 NC	2 NO	2 NC / 2 NO
--	-------------	------	------	-------------

Slow-action system

608100062
IN73-11 AHK

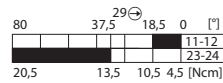

608100064
IN73-20 AHK

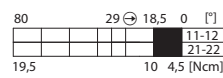

608100066
IN73-02 AHK

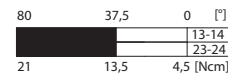

608100068
IN73-22 AHK

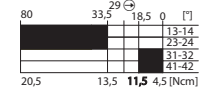

Snap-action system

608100061
IN73-S11 AHK

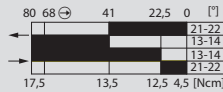

608100063
IN73-S20 AHK

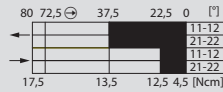

608100065
IN73-S02 AHK

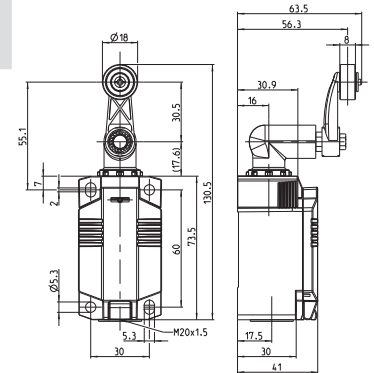
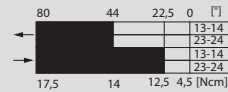

	4 NC	4 NO	3 NC / 1 NO	1 NC / 3 NO	1 NC / 1 NO overlapping
--	------	------	-------------	-------------	-------------------------

Slow-action system

608100069
IN73-40 AHK

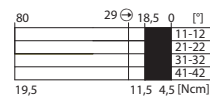

608100070
IN73-04 AHK

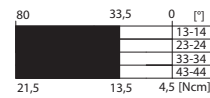

608100071
IN73-31 AHK

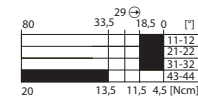

608100072
IN73-13 AHK

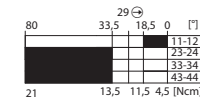

608100067
IN73-V11 AHK

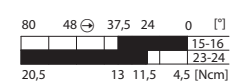

POSITION SWITCHES PLASTIC IN73

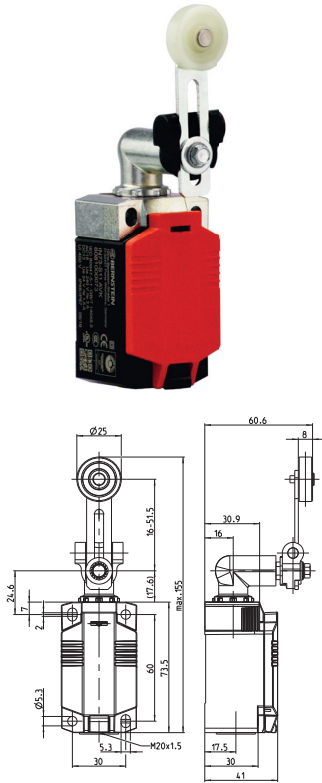

IN73-... AVK

Replacement actuator: 3918362424



	1 NC / 1 NO	2 NC	2 NO	2 NC / 2 NO
--	-------------	------	------	-------------

Slow-action system

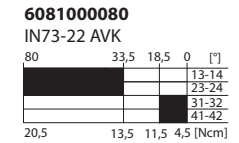
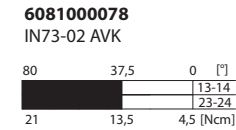
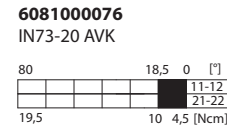
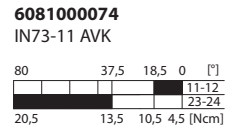

Snap-action system

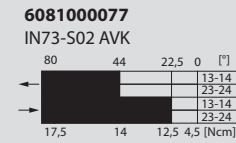
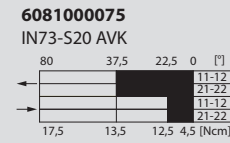
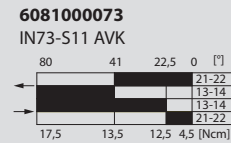

	4 NC	4 NO	3 NC / 1 NO	1 NC / 3 NO	1 NC / 1 NO overlapping
--	------	------	-------------	-------------	-------------------------

Slow-action system

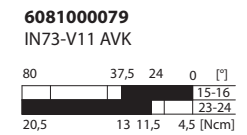
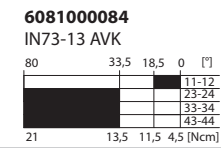
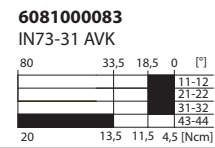
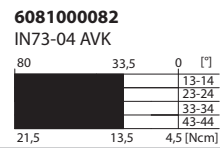
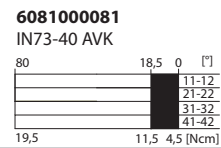



Replacement actuator: 3918372421

IN73-... AHDM

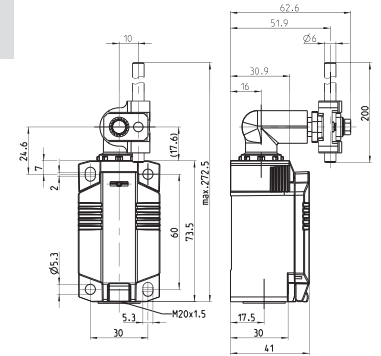

	1 NC / 1 NO	2 NC	2 NO	2 NC / 2 NO
--	-------------	------	------	-------------

Slow-action system

608100086
IN73-11 AHDM

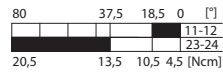

608100088
IN73-20 AHDM

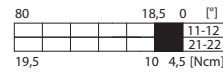

608100090
IN73-02 AHDM

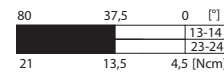

608100092
IN73-22 AHDM

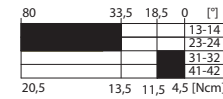

Snap-action system

608100085
IN73-S11 AHDM

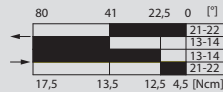

608100087
IN73-S20 AHDM

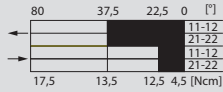

608100089
IN73-S02 AHDM

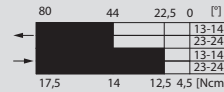

	4 NC	4 NO	3 NC / 1 NO	1 NC / 3 NO	1 NC / 1 NO overlapping
--	------	------	-------------	-------------	-------------------------

Slow-action system

608100093
IN73-40 AHDM

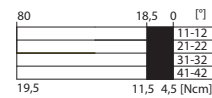

608100094
IN73-04 AHDM

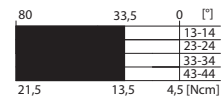

608100095
IN73-31 AHDM

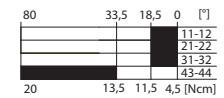

608100096
IN73-13 AHDM

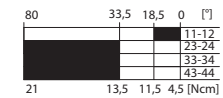

608100091
IN73-V11 AHDM

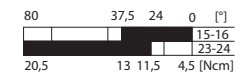

POSITION SWITCHES PLASTIC IN73



IN73-... AHGU RO50

Replacement actuator: 3918352422



	1 NC / 1 NO	2 NC	1 NC / 1 NO overlapping
Slow-action system	6081000109 IN73-11 AHGU Ro50 	6081000110 IN73-20 AHGU Ro50 	6081000111 IN73-V11 AHGU Ro50
Snap-action system	6081000108 IN73-S11 AHGU Ro50 		

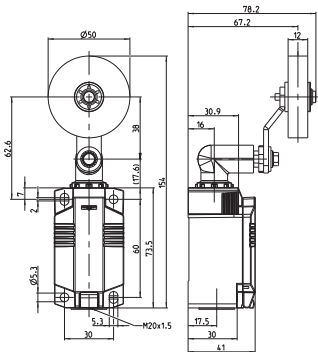

Replacement actuator: 3918362423

IN73-... AVGU RO50

	1 NC / 1 NO	2 NC	1 NC / 1 NO overlapping
Slow-action system	6081000105 IN73-11 AVGU Ro50 	6081000106 IN73-20 AVGU Ro50 	6081000107 IN73-V11 AVGU Ro50
Snap-action system	6081000104 IN73-S11 AVGU Ro50 		

